

# ROLLER DATA SHEET

COMPANY:

CONTACT:

PHONE #:

EMAIL:

APPROVED FOR MANUFACTURE BY:

DATE:

SIGNATURE

OEM PART #:

REPLACEMENT ROLL PART #:

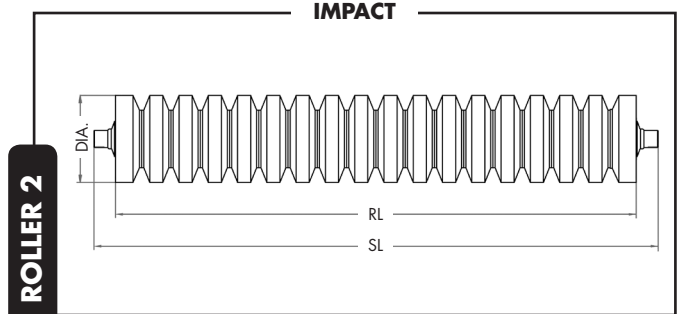
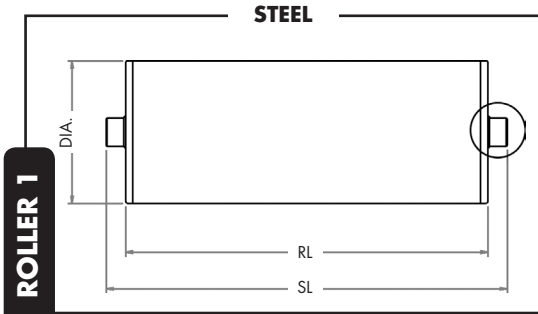

**CHOOSE YOUR ROLLER**

ROLLER 1 — STEEL

ROLLER 2 — IMPACT/DISC CARRYING

ROLLER 3 — RUBBER/URETHANE DISC RETURN

CHECK ONE

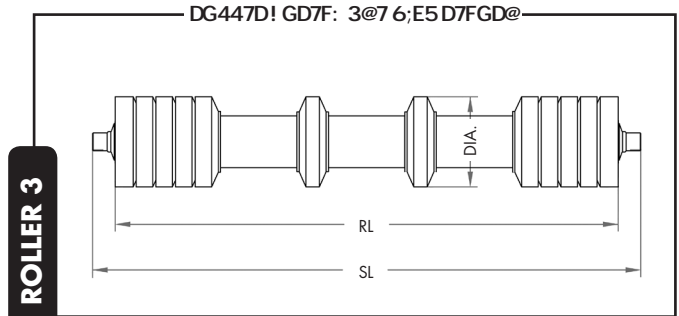

**CHOOSE YOUR STYLE**

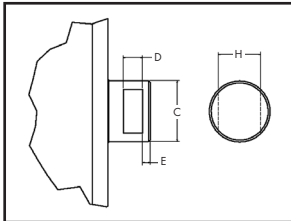

CHECK ONE

STYLE A

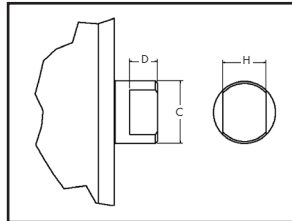

STYLE B

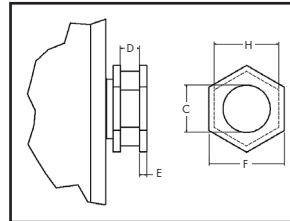

STYLE C

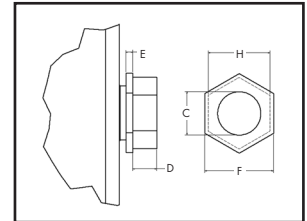

STYLE D

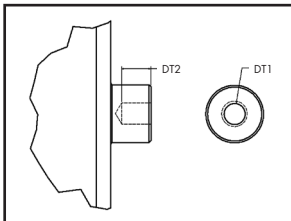

CHECK ONE

STYLE E

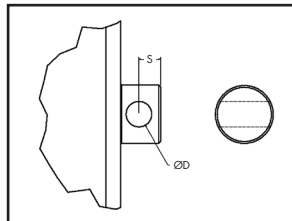

STYLE F

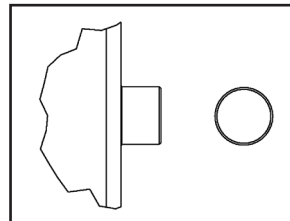

STYLE G



**QUESTIONS?**  
Call Toll-Free: 1.888.349.5833

QUANTITY	IDLER DIA.	ROLLER LENGTH (RL)	SHAFT LENGTH (SL)	CEMA SERIES	SHAFT DIA. (C)	LENGTH OF SLOT (D)	LENGTH OF SHOULDER (E)	HEX FLAT WIDTH (F)	THICKNESS OF SLOT (H)

ADAPTER NUMBER

**OR**

When STYLE E or F is used, replace above dimensions with: DT1 DT2 S ØD

Notes: